

# SH-2000, SH-2500, AB-3000, SH-4000 Bimetallic Steam Traps Installation and Operation Manual



SH-2500



SH-4000



SH-2000

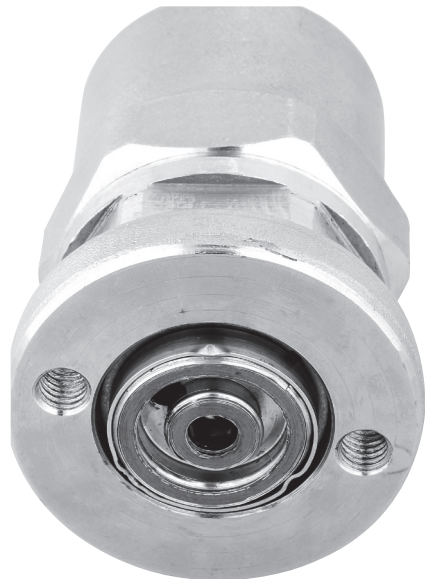

AB-3000



# Table of Contents

- General Safety Information . . . . . 2
- Product Information . . . . . 3
- Product Installation. . . . . 3
- Maintenance Requirements . . . . . 6
- Troubleshooting. . . . . 6
- Repair Parts. . . . . 7
- Limited Warranty and Remedy. . . . . 8

## General Safety Information

This bulletin should be used by qualified personnel as a guide to the installation of Armstrong SH-2000, SH-2500, AB-3000 and SH-4000 Bimetallic Steam Traps. Selection or installation of equipment should always be accompanied by competent technical assistance. You are encouraged to contact Armstrong International, Inc. or its local sales representative for additional information.

Caution: When working with high pressure/temperature steam, follow safe practices.

# Product Information

## Operation

Bimetallic type steam traps employ the temperature effect of a thermostatic bimetallic element. At start up, the steam traps have the ability to handle large condensate loads while the system is heating up. At this point the bimetallic element is contracted and the valve is fully open removing condensate and non-condensable gases from the system. When the system reaches steam temperature, the high temperature causes the bimetallic element to expand, pulling the valve stem to close the valve. The valve remains closed until enough condensate backs up cooling the bimetallic element. As the bimetallic element cools, the valve slightly opens to pass condensate and vent non-condensable gases. When steam temperature is achieved, the valve closes again.

# Product Installation

Before installation, verify that the maximum allowable pressure/temperature and maximum operating pressure of the trap are sufficient to handle the system design pressure and temperature. This information can be found on the label located on the trap.

Steam trap installation is critical from both a performance and maintenance aspect. Installation of the trap is simplified if you follow these guidelines.

1. Before installing the trap, ensure the line is clean. Blow down any strainers ahead of the trap.
2. Install the trap so that it is accessible for inspection and repair, below the drip point and close to the vertical drip leg.
3. The trap must be installed on a 2 bolt connector block (TVS-4000, IS2 or Standard Connector) See section "Installing Connector Blocks and Steam Traps on Connector blocks" for more details. Armstrong recommends the trap to be installed in a horizontal line.
4. Proper piping and drip legs of adequate size and diameter are essential for the successful operation of the Armstrong bimetallic traps, see Chart 3-1 and Figure 3-1.
5. Isolation valves are needed before and after traps. When starting a new trap, be sure to open the valve slowly.
6. Due to the high temperatures of steam, it might be necessary to guard the traps for personnel safety.

**Chart 3-1**

| M<br>Steam Main<br>Size (in) | D<br>Drip Leg<br>Diameter (in) | H<br>Drip Leg Length<br>Minimum (in) |                      |
|------------------------------|--------------------------------|--------------------------------------|----------------------|
|                              |                                | Supervised<br>Warm-Up                | Automatic<br>Warm-Up |
| 1/2                          | 1/2                            | 10                                   | 28                   |
| 3/4                          | 3/4                            | 10                                   | 28                   |
| 1                            | 1                              | 10                                   | 28                   |
| 2                            | 2                              | 10                                   | 28                   |
| 3                            | 3                              | 10                                   | 28                   |
| 4                            | 4                              | 10                                   | 28                   |
| 6                            | 4                              | 10                                   | 28                   |
| 8                            | 4                              | 12                                   | 28                   |
| 10                           | 6                              | 15                                   | 28                   |
| 12                           | 6                              | 18                                   | 28                   |
| 14                           | 8                              | 21                                   | 28                   |
| 16                           | 8                              | 24                                   | 28                   |
| 18                           | 10                             | 27                                   | 28                   |
| 20                           | 10                             | 30                                   | 30                   |
| 24                           | 12                             | 36                                   | 36                   |

**Figure 3-1**

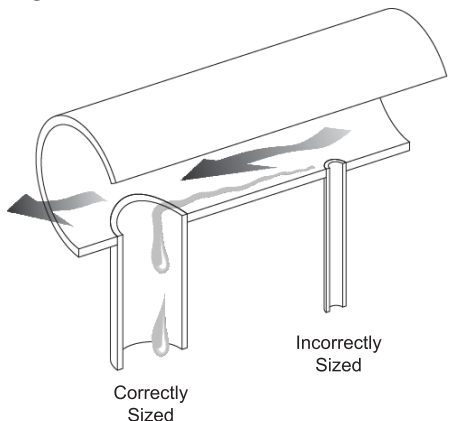

# Installing Connector Blocks and Steam Traps on Connector blocks

## Standard

The Standard connector block should be installed in piping with the flow direction stamp pointing in the correct direction as indicated on the connector block.

- The trap will then be bolted to the connector block after the connector block has been installed.
- When installing the trap to the connector block, apply 35-50 ft-lbs of torque to the bolts using a 9/16" wrench. Allow 2.5" clearance for bolt installation and removal.
- When starting a trap, be sure to open the valve slowly.

Note: Armstrong strongly recommends adding an upstream strainer and isolation valves upstream and downstream of the trap. Refer to figures 4.1 and 4.2.

Figure 4.1

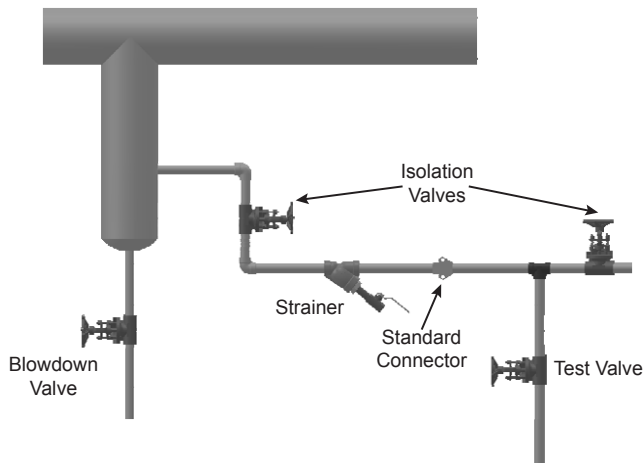
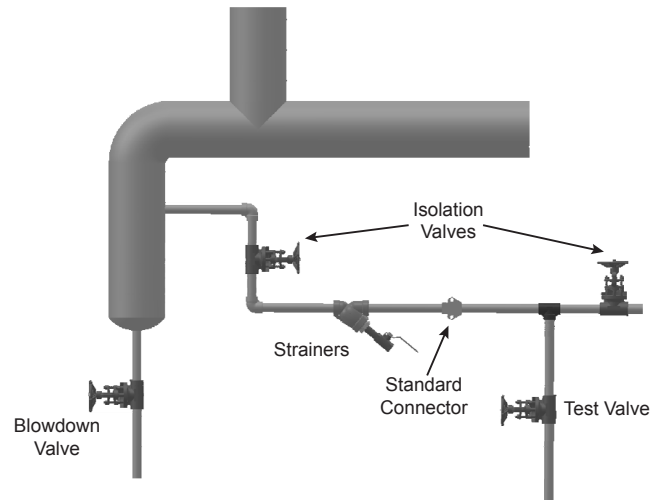

Figure 4.2



## IS2

The IS2 connector block should be installed in piping with the flow direction stamp pointing in the correct direction as indicated on the connector block.

- The trap will then be bolted to the connector block after the connector block has been installed.
- When installing the trap to the connector block, apply 35-50 ft-lbs of torque to the bolts using a 9/16" wrench. Allow 2.5" clearance for bolt installation and removal.
- When starting a trap, be sure to open the valve slowly.

Note: Armstrong strongly recommends isolation valves upstream and downstream of the trap. Refer to figures 5.1 and 5.1.

Figure 5.1

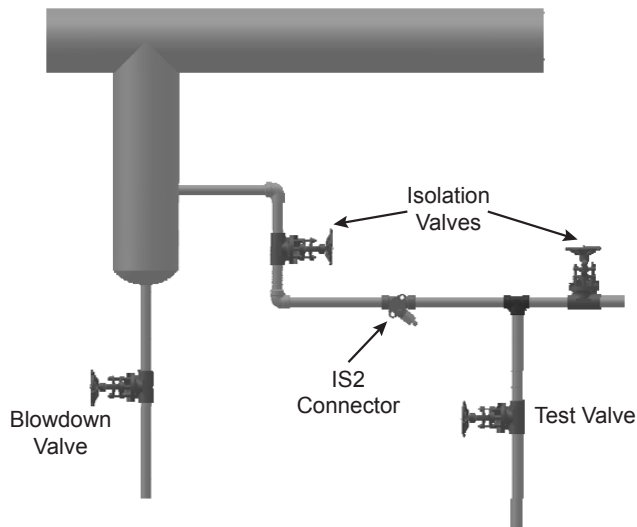
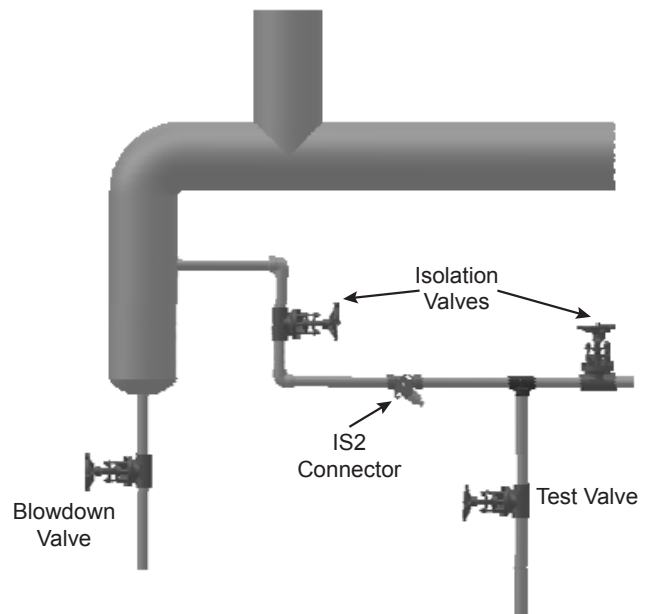

Figure 5.2



## TVS-4000

The TVS-4000/F connector block should be installed in piping with the flow direction stamp pointing in the correct direction as indicated on the connector block.

- The trap will then be bolted to the connector block after the connector block has been installed.
- When installing the trap to the connector block, apply 35-50 ft-lbs of torque to the bolts using a 9/16" wrench. Allow 2.5" clearance for bolt installation and removal.
- When starting a trap, be sure to open the valve slowly.

Note: The TVS-4000 has integral strainer and isolation valves. Refer to figures 5.3 and 5.4.

Figure 5.3

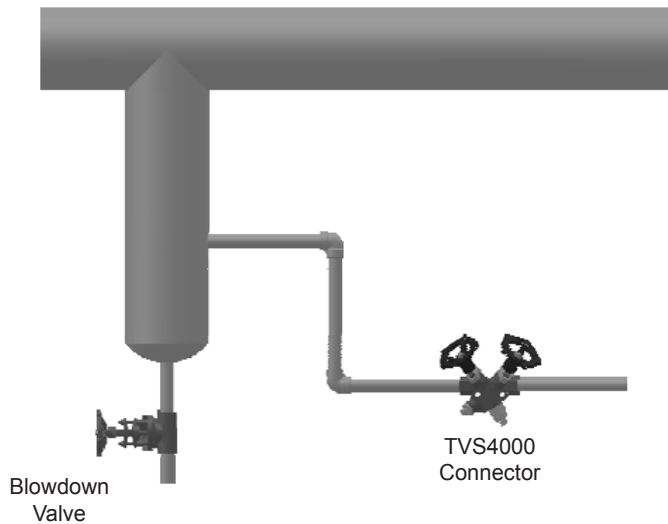
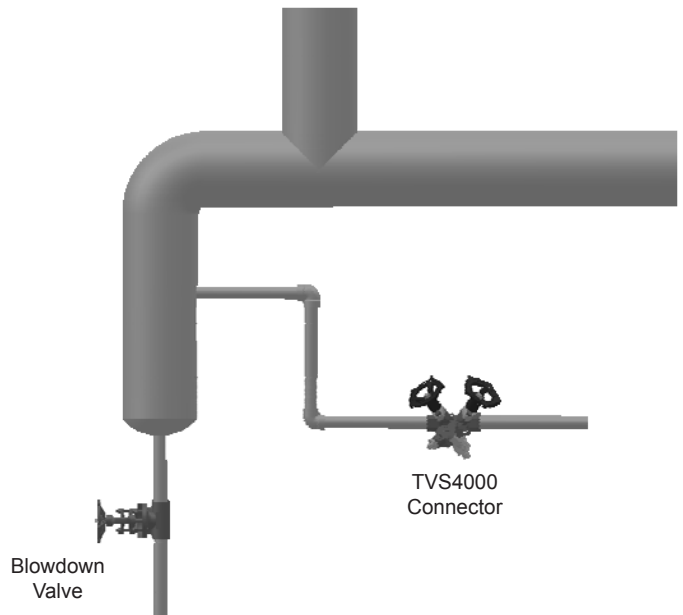

Figure 5.4



# Maintenance Requirements

High pressure drips traps should be tested at least three times per year.

When the bimetallic steam trap is suspected of malfunctioning, it can be checked by observing the discharge of the trap. Normal trap operation would be indicated by:

- Trap discharging condensate continuously (modulating)
- Trap discharge in cycles (on-off)

All discharges are accompanied by large amounts of flash steam.

Do not confuse the discharge of flash steam with live steam loss. If the trap continues to blow live steam, isolate the trap and repair or replace.

## Troubleshooting

Whenever a trap fails to operate and the reason is not readily apparent, the discharge from the trap should be observed. If the trap is installed with a test outlet or discharges to atmosphere, this will be a simple matter - otherwise, it will be necessary to break the discharge connection.

1. Cold Trap - No Discharge  
No condensate or steam coming to trap.
  - a) Stopped or plugged strainer ahead of trap.
  - b) Broken valve in line to trap.
  - c) Pipe line or elbows plugged.
  - d) Pressure reducing valve out of order.
  - e) Isolation valves are off/closed

Caution: Superheated steam is invisible. Do not place objects directly in the path of trap discharge. In a blow through situation a loud roar should be heard even though there may not be visible steam.

2. Steam Loss:  
If the trap leaks or blows live steam, trouble may be due to any of the following causes:
  - a) Valve may fail to seat
  - b) Piece of scale lodged in orifice
  - c) Worn parts

Imaginary Troubles: If it appears that steam escapes every time trap discharges, remember: Hot condensate forms flash steam when released to lower pressure, but usually condenses quickly in the return line.

3. Continuous Flow
  - A. Trap not up to temperature. Allow more time for condensate removal (on start-up).
  - B. On large loads the traps is working fine as designed.

If the trap is found defective:

1. Isolate the trap
2. Blow down/bleed off the internal pressure
3. With the connector block in line, remove the two bolts that hold the trap to the connector block using a 9/16" wrench.
4. Remove the trap from the connector block
5. Replace the failed trap with a working trap (refer to the installation section for details on how to install)

# Repair Parts

SH-2000: does not have repair part. If the trap fails, a new one will need to be installed

SH-2500: does not have repair part. If the trap fails, a new one will need to be installed

SH-4000: does not have repair part. If the trap fails, a new one will need to be installed

AB-3000

- Remove the steam trap from the connector block by taking the two bolts out
- Unscrew and lift the cap
- Unscrew and replace the bimetallic element
- The distance between the flat bimetallic element and the seat should be 2 mm
- Clean or replace the screen
- Put the cap back on the body and screw the cap
- Bolt the trap back to the connector block

# Limited Warranty and Remedy

Armstrong International, Inc. or the Armstrong division that sold the product (“Armstrong”) warrants to the original user of those products supplied by it and used in the service and in the manner for which they are intended, that such products shall be free from defects in material and workmanship for a period of one (1) year from the date of installation, but not longer than 15 months from the date of shipment from the factory, [unless a Special Warranty Period applies, as listed below]. This warranty does not extend to any product that has been subject to misuse, neglect or alteration after shipment from the Armstrong factory. Except as may be expressly provided in a written agreement between Armstrong and the user, which is signed by both parties, Armstrong DOES NOT MAKE ANY OTHER REPRESENTATIONS OR WARRANTIES, EXPRESS OR IMPLIED, INCLUDING, BUT NOT LIMITED TO, ANY IMPLIED WARRANTY OF MERCHANTABILITY OR ANY IMPLIED WARRANTY OF FITNESS FOR A PARTICULAR PURPOSE.

The sole and exclusive remedy with respect to the above limited warranty or with respect to any other claim relating to the products or to defects or any condition or use of the products supplied by Armstrong, however caused, and whether such claim is based upon warranty, contract, negligence, strict liability, or any other basis or theory, is limited to Armstrong’s repair or replacement of the part or product, excluding any labor or any other cost to remove or install said part or product, or at Armstrong’s option, to repayment of the purchase price. As a condition of enforcing any rights or remedies relating to Armstrong products, notice of any warranty or other claim relating to the products must be given in writing to Armstrong: (i) within 30 days of last day of the applicable warranty period, or (ii) within 30 days of the date of the manifestation of the condition or occurrence giving rise to the claim, whichever is earlier. IN NO EVENT SHALL ARMSTRONG BE LIABLE FOR SPECIAL, DIRECT, INDIRECT, INCIDENTAL OR CONSEQUENTIAL DAMAGES, INCLUDING, BUT NOT LIMITED TO, LOSS OF USE OR PROFITS OR INTERRUPTION OF BUSINESS. The Limited Warranty and Remedy terms herein apply notwithstanding any contrary terms in any purchase order or form submitted or issued by any user, purchaser, or third party and all such contrary terms shall be deemed rejected by Armstrong.



Armstrong International  
North America • Latin America • India • Europe / Middle East / Africa • China • Pacific Rim  
[armstronginternational.com](http://armstronginternational.com)