

VMSD - Manifold Installation & Operations Manual

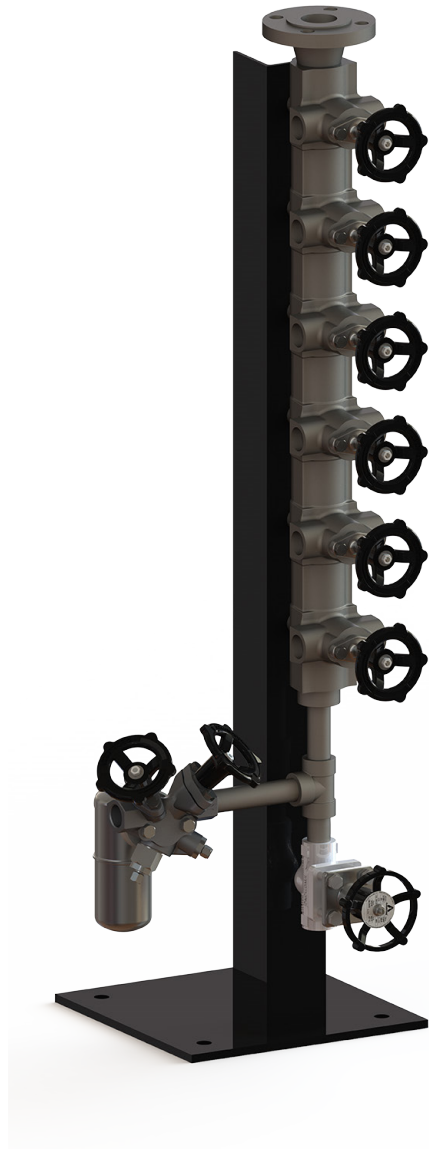

Please read and save
these instructions



Table of Contents

- General Safety Information** 3
- Product Information** 3
 - Operating Principal* 3
- Product Installation** 4
 - Start-Up Procedure* 5
 - Shut-Down Procedure* 5
- Maintenance Requirements** 6
- Troubleshooting** 7
- Repair Parts** 7
 - Standard Replacment Components* 7
- Limited Warranty and Remedy** 8

General Safety Information

This manual should be used by experienced personnel as a guide to the installation of the Armstrong VMSD manifold. Selection or installation of equipment should always be accompanied by competent technical assistance. You are encouraged to contact Armstrong International, Inc. or its local sales representative for additional information.

Product Information

A steam distribution manifold places all steam supply valves in one location. Standardizing components and centralizing their location simplifies installation while providing cost savings. You also save because routine maintenance is faster. Insulation can also be provided...and can be a major savings in most installations.

Operating Principal

1. General

- VMSD Manifold uses Piston valves, unique in that they assure leak tightness with a sealing system especially designed for steam systems. Valves seal by contact of the stainless steel piston to the graphite rings. A constant load is maintained on the sealing rings by disc springs.

2. Sealing Forces

- **Dual sealing action.** The piston valve is a seatless valve which includes two graphite and stainless steel valve sealing rings that seal the stem and function as a seat. This combination provides long-term protection against leaks to the atmosphere and downstream piping.
- **Self-cleaning action.** Stainless steel piston slides without rotating between the two valve sealing rings, preventing dirt from damaging the surfaces.
- **Sealing integrity.** Flexible disc springs automatically provide leak tightness by exerting pressure which keeps the upper and lower valve sealing rings compressed at all times. Sealing tightness is assured by the compression of the sealing rings against the piston and valve body. This combination of disc springs and dual valve seal rings protects against expansion and contraction due to heating and cooling. This assures dependable operation, even after years of service.
- **Protected valve stem.** The valve stem and sealing surfaces are completely protected from dirt and corrosion by the stem cap, whether in an open or closed position.
- **In-line reparability.** All sealing valve components may be easily replaced in-line.

3. Long-term operation. Piston valve design assures actuation even after many years without operation.

4. Operation

- The valve begins to stop flow when the valve plug enters the lower valve sealing ring.
- When the valve is completely closed, valve plug is in contact with the full height of the valve sealing rings, ensuring the best possible seal. In fact, there is no advantage to be gained in torquing the valve closed. **Armstrong recommends that after closing the valve completely, the handwheel should be turned back one half turn.** This makes it easy to re-open the valve by avoiding metal to metal seizure.

Product Installation

1. Before connecting the Value Manifold Steam Distribution (VMSD) to the system, blowdown the line at full pressure to clear the pipes of dirt, pipe cuttings, and/or welding beads.
2. VMSD may be installed vertically, horizontally, or they may be inclined without affecting the way they operate. Vertical installation is preferable, because it saves space and improves the removal of condensate that may form in the manifold.
3. If tracers are to be welded to the outlet parts of the valves, be sure the valves are in the closed position. The sealing rings do not have to be removed, but closing the valve allows the piston to protect the sealing rings.
4. The manifold needs to be fixed onto the support only by means of the upper and lower threaded bosses at the back. Only two supports are needed, and using the upper and lower minimizes shifting. Provide some space if you plan to insulate.

If these instructions are followed, very little maintenance should be required.

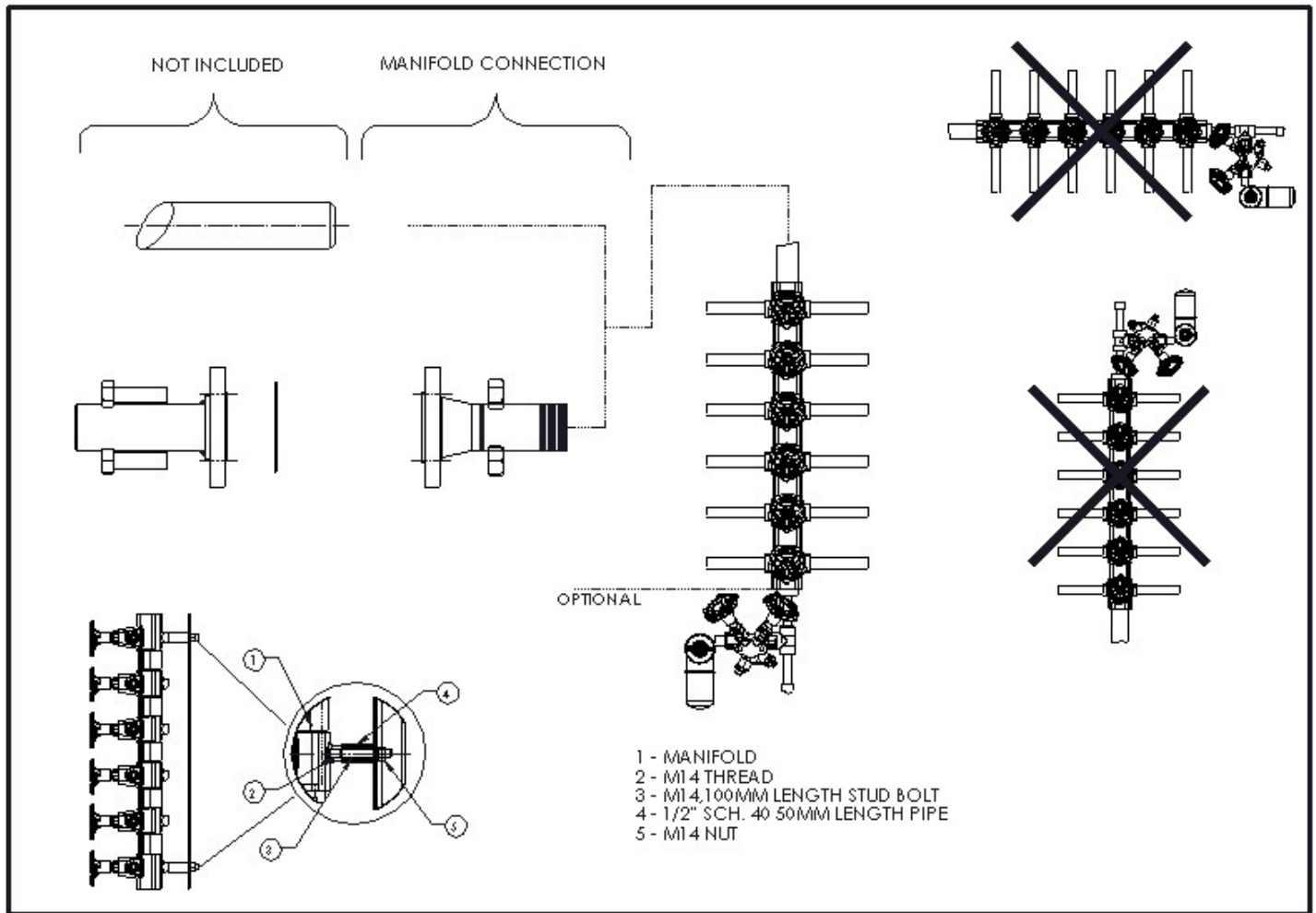

Start-Up Procedure

For detailed hook-ups and adapted start-up and shut-down procedures, see Armstrong literature or consult your local Representative.

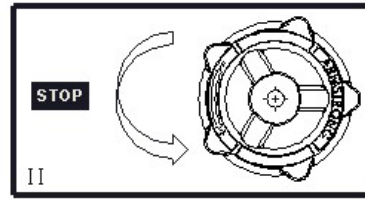
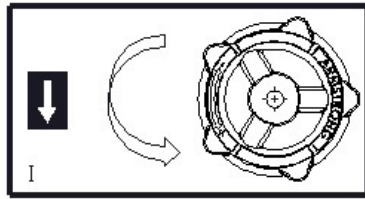

Shut-Down Procedure

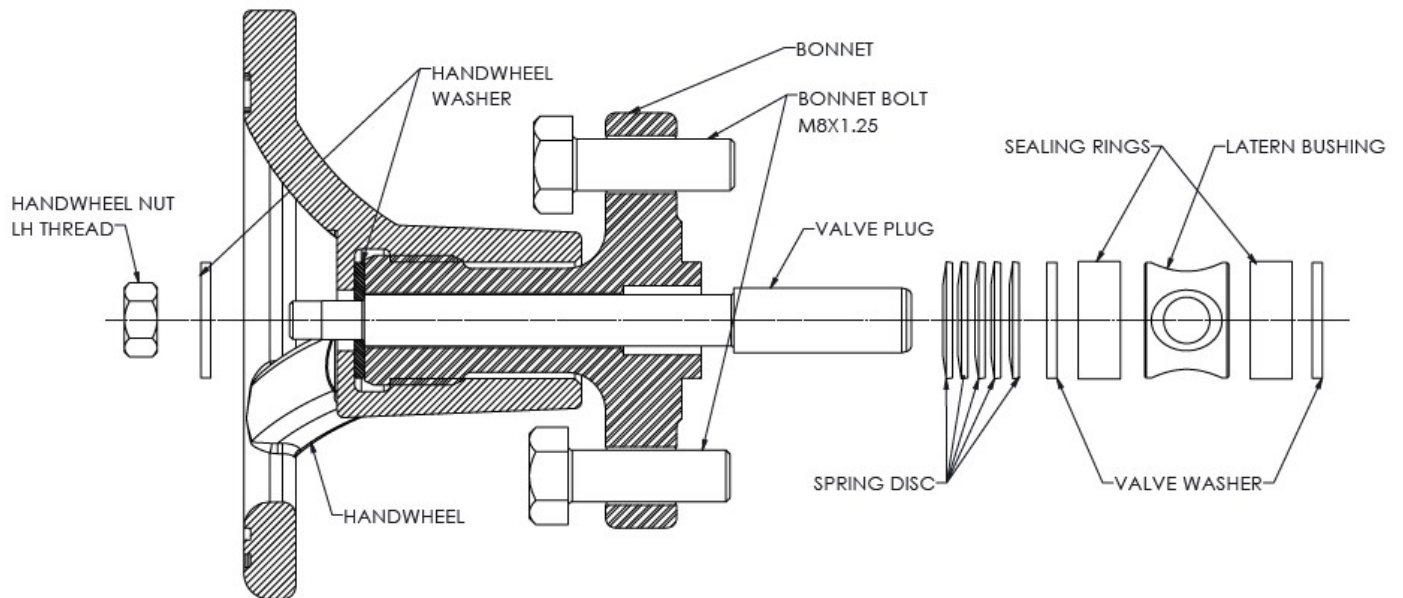
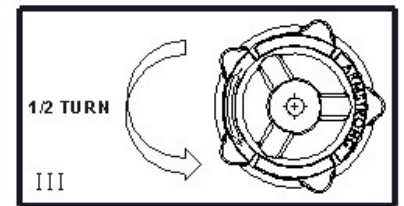
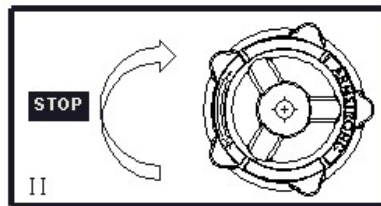
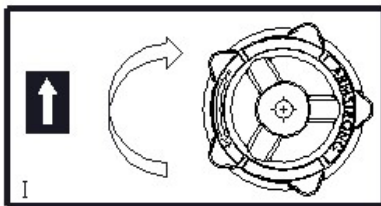

Maintenance Requirements

A piston valve will retain its leak tightness for several years without maintenance. In severe service, such as rapid heating and cooling, some field maintenance may be required. Depending on the problem, these simple steps may help:

- 1. Valve leaks when the valve is closed. First, check to make sure the valve is actually closed.** Check to see if bonnet is seated on the body, if not, tighten the bonnet bolts until the bonnet seats. This recompresses the valve sealing rings against the body and the valve plug. If valve continues to leak, replace the valve assembly.
- 2. Valve stem leaks.** Same as above.
- 3. Maintain the valve as soon as leakage starts.** Internal leakage can wear the valve plug or valve sealing rings and they will have to be replaced if leakage continues.

CAUTION: BEFORE TIGHTENING THE BONNET BOLTS, MAKE SURE THE VALVE IS IN THE CLOSED POSITION.

Remove the valve sealing rings, Lantern bushing and valve washers using a packing hook. This can be done in the field. **Be sure to isolate the manifold and valve from flow and system pressure before doing any maintenance.**

1. Loosen the bonnet bolts "M8x1.25" and remove from body.
2. Pull bonnet assembly out of valve body.
3. Remove the disc springs, valve sealing rings, valve washers and lantern bushing using a Packing Hook. Check to see if all components including the valve washer at bottom of valve body have been removed. Inspect and clean any debris that might have remained in the valve body.

Installing New Manifold Valve Assembly

1. Place Armstrong valve assembly kit in manifold body as shown in Fig 5.1 (Armstrong part # : B5148). (The piston and sealing rings have been lubricated at the factory).
2. Align the bonnet holes and lightly push the valve assembly to the bottom of the manifold body.
3. Coat the threads of the bonnet bolt "M8x1.25" with "never seize" and **tighten the bolts evenly** until the bonnet seats on the valve body.
4. Check the valve for proper operation by opening and closing the valve one or two times leaving them in the open position.
5. Open isolation valves up and down stream from the manifold and check for leaks.

Troubleshooting

Problem	Causes	Solution
Leakage	Bonnet not seated properly	Follow the steps, stated in maintenance requirements
	Valve ring damaged	Replace the manifold valve assembly kit

Repair Parts

To order replacement parts, Contact your Armstrong Representative if further assistance is required.

The pipes must be properly purged and degassed before dismantling the manifold assembly.

Standard Replacment Components

Description	Part Number
Manifold Valve Assembly KIT	B5148

Limited Warranty and Remedy

Armstrong International, Inc. or the Armstrong division that sold the product (“Armstrong”) warrants to the original user of those products supplied by it and used in the service and in the manner for which they are intended, that such products shall be free from defects in material and workmanship for a period of one (1) year from the date of installation, but not longer than 15 months from the date of shipment from the factory, [unless a Special Warranty Period applies, as listed below]. This warranty does not extend to any product that has been subject to misuse, neglect or alteration after shipment from the Armstrong factory. Except as may be expressly provided in a written agreement between Armstrong and the user, which is signed by both parties, Armstrong **DOES NOT MAKE ANY OTHER REPRESENTATIONS OR WARRANTIES, EXPRESS OR IMPLIED, INCLUDING, BUT NOT LIMITED TO, ANY IMPLIED WARRANTY OF MERCHANTABILITY OR ANY IMPLIED WARRANTY OF FITNESS FOR A PARTICULAR PURPOSE.**

The sole and exclusive remedy with respect to the above limited warranty or with respect to any other claim relating to the products or to defects or any condition or use of the products supplied by Armstrong, however caused, and whether such claim is based upon warranty, contract, negligence, strict liability, or any other basis or theory, is limited to Armstrong’s repair or replacement of the part or product, excluding any labor or any other cost to remove or install said part or product, or at Armstrong’s option, to repayment of the purchase price. As a condition of enforcing any rights or remedies relating to Armstrong products, notice of any warranty or other claim relating to the products must be given in writing to Armstrong: (i) within 30 days of last day of the applicable warranty period, or (ii) within 30 days of the date of the manifestation of the condition or occurrence giving rise to the claim, whichever is earlier. **IN NO EVENT SHALL ARMSTRONG BE LIABLE FOR SPECIAL, DIRECT, INDIRECT, INCIDENTAL OR CONSEQUENTIAL DAMAGES, INCLUDING, BUT NOT LIMITED TO, LOSS OF USE OR PROFITS OR INTERRUPTION OF BUSINESS.** The Limited Warranty and Remedy terms herein apply notwithstanding any contrary terms in any purchase order or form submitted or issued by any user, purchaser, or third party and all such contrary terms shall be deemed rejected by Armstrong.

*Designs, materials, weights and performance ratings are approximate and subject to change without notice.
Visit armstronginternational.com for up-to-date information.*



Armstrong International
North America • Latin America • India • Europe / Middle East / Africa • China • Pacific Rim
armstronginternational.com